



EN Operating instructions.pages 1 to 4
Translation of the original operating instructions

Content

1 About this document

1.1 Function 1

1.2 Target group: authorised qualified personnel. 1

1.3 Explanation of the symbols used 1

1.4 Appropriate use 1

1.5 General safety instructions 1

1.6 Warning about misuse 1

1.7 Exclusion of liability 2

2 Product description

2.1 Ordering code 2

2.2 Special versions. 2

2.3 Destination and use 2

2.4 Technical data 2

2.5 Safety classification 2

3 Mounting

3.1 General mounting instructions 2

3.2 Dimensions 3

4 Electrical connection

4.1 General information for electrical connection. 3

4.2 Contact variants. 3

5 Set-up and maintenance

5.1 Functional testing. 3

5.2 Maintenance 3

6 Disassembly and disposal

6.1 Disassembly. 3

6.2 Disposal. 3

7 Appendix

7.1 EC Declaration of conformity 4

1. About this document

1.1 Function

This operating instructions manual provides all the information you need for the mounting, set-up and commissioning to ensure the safe operation and disassembly of the safety switchgear. The operating instructions must be available in a legible condition and a complete version in the vicinity of the device.

1.2 Target group: authorised qualified personnel

All operations described in this operating instructions manual must be carried out by trained specialist personnel, authorised by the plant operator only.

Please make sure that you have read and understood these operating instructions and that you know all applicable legislations regarding occupational safety and accident prevention prior to installation and putting the component into operation.

The machine builder must carefully select the harmonised standards to be complied with as well as other technical specifications for the selection, mounting and integration of the components.

1.3 Explanation of the symbols used



Information, hint, note:
This symbol is used for identifying useful additional information.



Caution: Failure to comply with this warning notice could lead to failures or malfunctions.
Warning: Failure to comply with this warning notice could lead to physical injury and/or damage to the machine.

1.4 Appropriate use

The products described in these operating instructions are developed to execute safety-related functions as part of an entire plant or machine. It is the responsibility of the manufacturer of a machine or plant to ensure the correct functionality of the entire machinery or plant.

The safety switchgear must be exclusively used in accordance with the versions listed below or for the applications authorised by the manufacturer. Detailed information regarding the range of applications can be found in the chapter "Product description".

1.5 General safety instructions

The user must observe the safety instructions in this operating instructions manual, the country-specific installation standards as well as all prevailing safety regulations and accident prevention rules.



Further technical information can be found in the Schmersal catalogues or in the online catalogue on the Internet: www.schmersal.net.

The information contained in this operating instructions manual is provided without liability and is subject to technical modifications.

There are no residual risks, provided that the safety instructions as well as the instructions regarding mounting, commissioning, operation and maintenance are observed.

1.6 Warning about misuse



In case of improper use or manipulation of the safety switchgear, personal hazards or damages to machinery or plant components cannot be excluded when safety switchgear is used. The relevant requirements of the standard ISO 14119 must be observed.

1.7 Exclusion of liability

We shall accept no liability for damages and malfunctions resulting from defective mounting or failure to comply with this operating instructions manual. The manufacturer shall accept no liability for damages resulting from the use of unauthorised spare parts or accessories.

For safety reasons, invasive work on the device as well as arbitrary repairs, conversions and modifications to the device are strictly forbidden; the manufacturer shall accept no liability for damages resulting from such invasive work, arbitrary repairs, conversions and/or modifications to the device.

2. Product description

2.1 Ordering code

This operating instructions manual applies to the following types:

EX-TV①S 335-②Z-③-3D

| No. | Option | Description |
|-----|--------|-------------------------------|
| ① | 8 | Shaft bore Ø 8 mm |
| | 10 | Shaft bore Ø 10 mm |
| ② | 02 | 2 NC contacts |
| | 03 | 3 NC contacts |
| | 11 | 1 NO contacts / 1 NC contacts |
| | 12 | 1 NO contacts / 2 NC contacts |
| ③ | | cable entry M20 |



Only if the information described in this operating instructions manual are realised correctly, the safety function and therefore the compliance with the Machinery Directive and the Explosion Protection Directive is maintained.

2.2 Special versions

For special versions, which are not listed in the order code below 2.1, these specifications apply accordingly, provided that they correspond to the standard version.

2.3 Destination and use

The hinge safety switches are suitable for hinged guards in explosive atmospheres of Zone 22, category 3D, which need to be closed in order to provide for the necessary operational safety. The installation and maintenance requirements to the standard series EN 60079 must be met.

Conditions for safe operation

Due to the specific impact energy, the components must be fitted with a protection against mechanical stresses. The specific ambient temperature range must be observed.



The user must evaluate and design the safety chain in accordance with the relevant standards and the required safety level.

2.4 Technical data

| | |
|---------------------|--|
| Equipment category: | ⊕ II 3D |
| Ex protection: | Ex tc IIIC T90°C Dc X |
| Standards: | IEC 60947-5-1, EN 60079-0, EN 60079-31, BG-GS-ET-15 |
| Enclosure: | light-alloy diecast, paint finish |
| Actuator: | stainless steel 1.4301 |
| Max. impact energy: | 4 J |
| Actuating speed: | max. 1 ms |
| Protection class: | IP67 to EN 60529 |
| Contact material: | Silver |
| Contact type: | change-over with double break Zb, or 3 NC contacts, galvanically separated contact bridges |
| Switching system: | ⊖ IEC 60947-5-1; slow action, NC contact with positive break |
| Connection: | screw terminals |
| Cable section: | min. 0.75 mm ² - max. 2.5 mm ² (including conductor ferrules) |

| | |
|---|-------------------------------|
| Cable entry: | M20 x 1.5 |
| Rated impulse withstand voltage U_{imp} : | 6 kV |
| Rated insulation voltage U_i : | 500 V |
| Thermal test current I_{th} : | 10 A |
| Utilisation category: | AC-15 / DC-13 |
| Rated operating current/voltage I_e/U_e : | 4 A / 230 VAC 4 A / 24 VDC |
| Max. fuse rating: | 6 A gG D-fuse |
| Positive break travel: | 10.7 mm |
| Positive break force: | each NC contact 5 N |
| Ambient temperature: | -20 °C ... + 60 °C |
| Mechanical life: | max. 1 million operations |
| Switching frequency: | max. 1000 / h |
| Shaft bore: | Ø 8 mm / 10 mm |
| Positive break angle: | 7° |
| Positive break torque: | 0,6 Nm |
| Cable cross-section: | min. Ø 7 mm; max. Ø 12 mm |
| Cable glands: | ⊕ II 2GD |
| Tightening torque cover screws: | min. 1.0 Nm |
| Tightening torque cable gland: | min. 8 Nm |

2.5 Safety classification

| | |
|-------------------------|-------------|
| Standards: | ISO 13849-1 |
| B_{10d} (NC contact): | 20,000,000 |
| Service life: | 20 years |

$$MTTF_d = \frac{B_{10d}}{0,1 \times n_{op}} \quad n_{op} = \frac{d_{op} \times h_{op} \times 3600 \text{ s/h}}{t_{cycle}}$$

(Specifications can vary depending on the application-specific parameters h_{op} , d_{op} , t_{cycle} as well as the load.)

3. Mounting

3.1 General mounting instructions



Fitting is only authorised in a de-energised condition

The enclosure can be fixed by means of 4 mounting holes. The mounting dimensions are mentioned at the rear of the enclosure. The fixing screws must be protected against unauthorised tampering. The use of a protective ground wire is imperative. The enclosure must not be used as an end stop. Any mounting position.

Fit the hinge safety switch so that the shaft of the hinge safety switch is aligned with the pin of the door hinge. Use the supplied tamperproof safety screws to fix the hinge safety switch. To set the switching point, first adjust the plug/shaft connection by means of a threaded pin. Then establish the positive link between the shaft and the door hinge. To that effect, use the offset arranged mounting holes and the supplied spiral clamping pin. The head can be turned by 4 x 90°. Loosen the four screws of the head by means of a Torx screwdriver (T 20), turn the head in the desired position and retighten the screws.

Shaft bore A TV8S 335 Ø 8 mm
 TV10S 335 Ø 10 mm

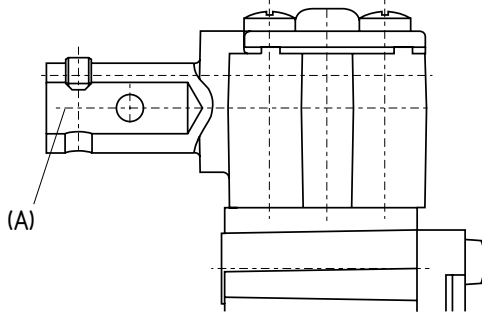

Please observe the recommendations regarding maximum impact energy, actuating speed and tightening torque in the technical data.



Please observe the remarks of the standards ISO 12100, EN 953 and ISO 14119.

3.2 Dimensions

All measurements in mm.

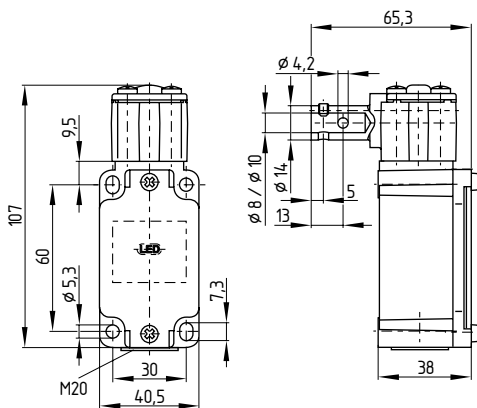

4. Electrical connection

4.1 General information for electrical connection



The electrical connection may only be carried out by authorised personnel in a de-energised condition.

The contact labelling can be found in the wiring compartment of the switch. Cable glands (included in delivery) are only authorised for permanent cables. The constructor must provide for the necessary strain relief. After wiring, dust and soiling must be removed from the wiring compartment.

4.2 Contact variants

Contacts are shown with safety guard closed.

1 NO contacts / 1 NC contacts

EX-TV.S 335-11Z-3D



2 NC

EX-TV.S 335-02Z-3D

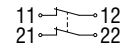

1 NO contacts / 2 NC contacts

EX-TV.S 335-12Z-3D

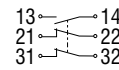

3 NC

EX-TV.S 335-03Z-3D

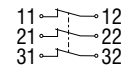

5. Set-up and maintenance

5.1 Functional testing

The safety function of the safety components must be tested. The following conditions must be previously checked and met:

- The installation is executed according to the instructions
- The connection is executed correctly
- The cable is correctly executed and connected
- Check the free movement of the actuating element
- The safety component is not damaged
- Remove particles of dust and soiling
- Check cable entry and connections in de-energised condition
- Check for correct installation of the hinge safety switch
- Check the positive link between the shaft and the door hinge

5.2 Maintenance

In case of correct installation in accordance with the instructions described above, the component requires little maintenance. For use in extreme conditions, we recommend routine maintenance including the following steps:

1. Check for correct installation of the hinge safety switch
2. Lubricate the shaft or plunger
3. Remove particles of dust and soiling
4. Check cable entry and connections in a de-energised condition



Do not open the device when live.



Adequate measures must be taken to ensure protection against tampering either to prevent tampering of the safety guard, for instance by means of replacement actuators.

Damaged or defective components must be replaced.

For explosion protection reasons, the component must be exchanged after max. 1 million operations.

6. Disassembly and disposal

6.1 Disassembly

The safety switchgear must be disassembled in a de-energised condition only.

6.2 Disposal

The safety switchgear must be disposed of in an appropriate manner in accordance with the national prescriptions and legislations.

7.1 EC Declaration of conformity

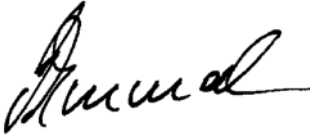
| | |
|---|---|
|  | |
| EC Declaration of conformity | |
| Translation of the original Declaration of Conformity | K.A. Schmersal GmbH & Co. KG Möddinghofe 30 42279 Wuppertal Germany Internet: www.schmersal.com |
| We hereby certify that the hereafter described safety components both in its basic design and construction conform to the applicable European Directives. | |
| Name of the safety component: | EX-TV.S 335 ⊕ II 3D Ex tc IIIC T90°C Dc X |
| Description of the safety component: | Hinge safety switch |
| Relevant EC-Directives: | 2006/42/EC EC-Machinery Directive 94/9/EC EC-Explosion Protection Directive (ATEX) |
| Used harmonised standards: | IEC 61508, EN 61241-0, EN 61241-1, |
| Person authorised for the compilation of the technical documentation: | Oliver Wacker Möddinghofe 30 42279 Wuppertal |
| Place and date of issue: | Wuppertal, January 8, 2015 |
| EX-TV.S335-C-EN |  |
| | Authorised signature Philip Schmersal Managing Director |



The currently valid declaration of conformity can be downloaded from the internet at www.schmersal.net.



K.A. Schmersal GmbH & Co. KG
Möddinghofe 30, D - 42279 Wuppertal
Postfach 24 02 63, D - 42232 Wuppertal

Phone: +49 - (0)2 02 - 64 74 - 0
Telefax: +49 - (0)2 02 - 64 74 - 1 00
E-Mail: info@schmersal.com
Internet: <http://www.schmersal.com>